



www.claypaky.it



ALPHA 1500

Profile | Spot HPE | Beam | Wash | Wash LT

ALPHA 1500

TABLE OF CONTENTS

Alpha range 1500	page 4-7
Alpha Spot features shared	page 8-9
Alpha Profile 1500	page 10-13
Alpha Spot HPE 1500	page 14-17
Alpha Beam 1500	page 18-21
Alpha Wash 1500 Wash 1500 LT	page 22-25
Alpha 1500 overview	page 26-27
Photometrics	page 28-29
Patents	page 29
Size and Weight	page 30
Accessories	page 30





Alpha Wash 1500

Alpha Spot HPE 1500

Alpha Profile 1500

THE ALPHA RANGE 1500

Light beyond imagination

Clay Paky has provided lighting designers with the most powerful spot and wash lights available: the new Alpha 1500 line. The pulsing heart of these new automated lights is their high performance optical system, the source of an incredibly bright beam of clean uniform light.

The remarkable output of the single-ended 1500 W Lok-It bulb is ingeniously driven through a sophisticated array of motorized lenses, which provides precise control over the beam angle and projection through the innovative Stay-Sharp-Zoom and Zoom-Tracking-Diffuser functions.

However, Alphas 1500 are more than just powerful lights. They feature an extremely rich range of functions: infinite colour choices, the industry's most creative imagery, limitless control of beam size and shape, unsurpassed movement speed and acceleration and an extraordinarily friendly user interface.

With the Alpha 1500 Series, Clay Paky has produced tools that enhance the lighting designer's creativity, rather than just supporting it. Designers may go beyond the limits of their own imagination and reach new levels of creative freedom.

Despite their breathtaking power, Alphas 1500 are the smallest and lightest fixtures in their category. They also feature Clay Paky's legendary superior quality, enhanced with completely new electronics and innovative mechanical design.

The Alpha 1500 range includes five top level models:

- ALPHA PROFILE 1500, the most powerful moving head spotlight. It features a unique framing system that allows extremely precise and versatile beam shape control (patented), making this light the most suitable for the most demanding lighting sets.
- ALPHA SPOT HPE 1500, the most impressive visual effect moving head, with an incredible array of imagery devices, including the innovative "automated star gobo" (patent pending) and the Dyna-Cue-Creator, a tool helping to generate fantastic dynamic cues.
- ALPHA BEAM 1500, the most powerful light in the new fully automated ACL fixture category. It generates a solid, super-concentrated parallel beam for very long-throw projection. Innumerable devices shape the beam size and animate it with colour and movement for fantastic mid-air effects.
- ALPHA WASH 1500, a washlight that generates an astounding beam. It is fully sizeable, thanks to the extra-wide 1:7 ratio zoom range. The beam is clean from centre to edge with limitless colour and shade selection.
- ALPHA WASH 1500 LT, a special moving head, generating a powerful long-throw coloured

A light that charms for its power and quality

It is clear to expert lighting designers that Alpha 1500s generate superior quality light. They use a new light source whose performance is optimized by the extraordinary optical unit developed by Clay Paky, that ensures incomparable even diffusion and projection sharpness. All versions are equipped with a super-fast zoom (120 bpm), with an extreme beam angle range (different according to the model).

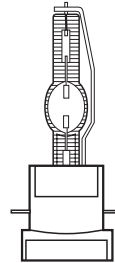

LIGHT SOURCE	Osram Lok-it
Power consumption	1,500 W
Color temperature	6,000 K
Luminous flux	135,000 lumen
Nominal life	750 h
Socket	PGJ50

Feline agility

Alpha 1500s are also spectacular in the speed and smoothness of their movements. Despite their mighty wattage, their heads move with amazing speed. The acceleration is virtually instantaneous and their reproducible movements are meticulously precise and perfect.

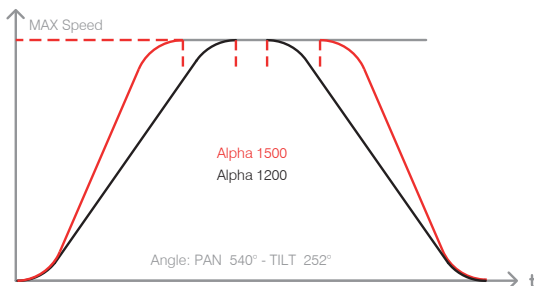

The three-phase motors respond instantaneously to the control signals.

Effects speed table			
Excursion	Fixed gobos	Rotating gobos	Color wheel
0 > 1	0.150 sec	0.224 sec	0.157 sec
0 > 2	0.198 sec	0.282 sec	0.199 sec
0 > 3	0.234 sec	0.328 sec	0.236 sec
0 > 4	0.269 sec	0.370 sec	0.269 sec
0 > 5	0.269 sec	0.400 sec	0.280 sec
0 > 6	0.234 sec	0.560 sec	0.314 sec
0 > 7	0.198 sec	-	-
0 > 8	0.150 sec	-	-

The speed of the movements and effects takes your breath away.

Main functions speed			
Parameter	Excursion	Time normal speed	Time fast speed (default)
PAN	0>100%	4.202 sec	3.897 sec
TILT	0>100%	2.391 sec	2.111 sec
IRIS	0>100%	0.148 sec	-
Zoom (Spot)	0>100%	0.535 sec	-
Zoom (Wash)	0>100%	2.850 sec	-
CMY	0>100%	0.470 sec	-

The 16-bit resolution ensures precise, linear, repeatable, smooth movements.

Surprising silence

Alpha 1500 lights are among the most silent in their power category. They are therefore also perfect for indoor use, such as in TV studios and theatres. Their motorized functions are noise-free, even at the highest frequencies: pan and tilt, gobo and colour wheel rotations, visual effects, zoom and the strobe. Optimal air-flow channelling drastically reduces cooling system noise.

Noise can be further reduced by decreasing output power from 1500 to 1200 W.

Fixture	Noise level full power (1500W)	Noise level half power (1200W)	Background noise
Profile 1500	47,5 dBA	45 dBA	34 dBA
Spot HPE 1500	46,5 dBA	44 dBA	34 dBA
Wash 1500	46 dBA	43,5 dBA	34 dBA

Perfectly gradual dimmer and instant flashing

The Alpha 1500 dimmer is a hybrid system. It is electronic from 100% to 50%, and mechanical from 50% to zero. Electronic dimming leads to energy savings and longer lamp life. The 16-bit resolution ensures both uniformity and precise control. A shutter-blade is also available for an instant black-out and adjustable rate strobe effect.

The user can choose from two dimmer curves which differ mainly in the gradient of the black-out inception.

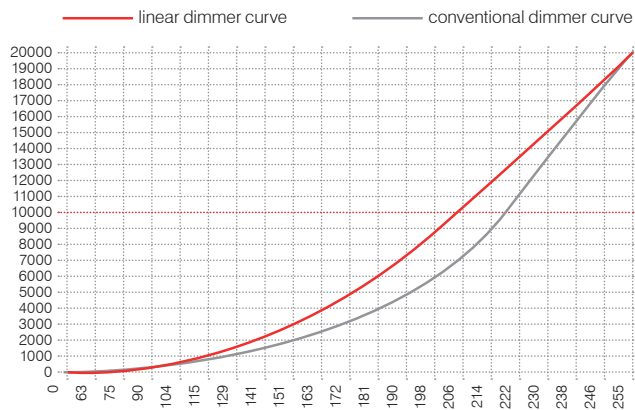

DMX Level	Linear Curve (default)	Conventional curve
0	0	0
63	2	3
75	25	30
90	146	150
104	300	220
115	800	450
129	1380	820
141	2130	1340
151	3120	1930
163	4080	2680
172	5180	3500
181	6310	4310
190	7590	5280
198	8930	6390
206	10290	7880
214	11780	9370
222	13400	11150
230	15100	13240
238	16750	15500
246	18560	17770
255	20300	20300

A plunge into the world of colours

All Alpha 1500 models have a powerful set of devices for colouring the light beam. The dichroic filters are extremely high quality, with carefully selected shades according to the colour spectrum of the lamp and the use of each model. A dedicated channel hosts macros with a preset colour range, which are interesting for their uniqueness and for frequent use.

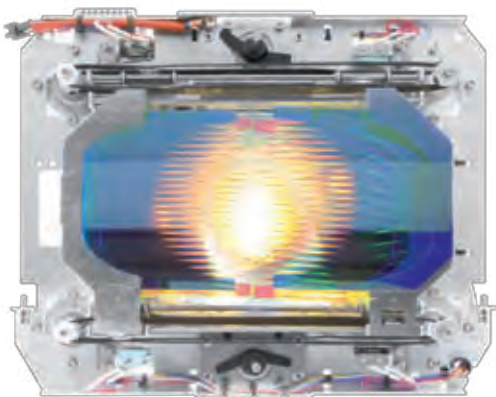

CMY

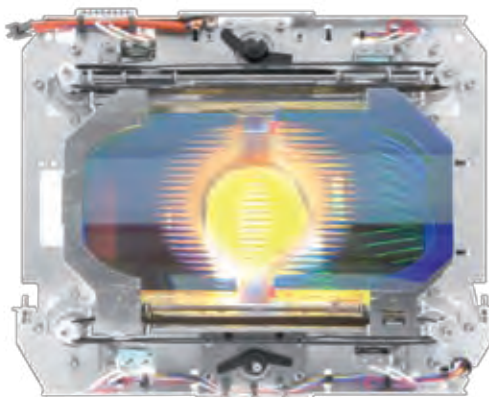

CTO



color wheel

The colour engine includes a subtractive colour mixing CMY system, a colour temperature correction CTO system and wheels with special fixed colours

AN ARRAY OF STRIKING FEATURES SHARED BY ALL FIVE ALPHA 1500 MODELS

Cutting-edge technology that aids creativity

Alpha 1500s were created to be the best, not only in terms of power. In the hands of lighting designers, they are high precision tools for creating refined and technically exemplary shows. However those who use them quickly discover that they are an endless source of highly creative solutions and ideas that can be developed for use at events. The user has complete control over the characteristics of each of the five versions, thanks to a large number of sophisticated devices, which depend on the model.

CMY system working area

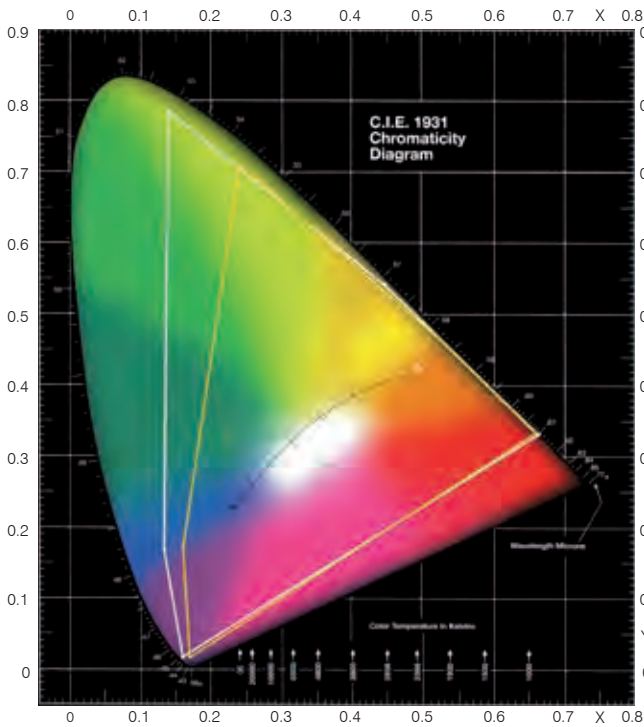

Fixed Colour position

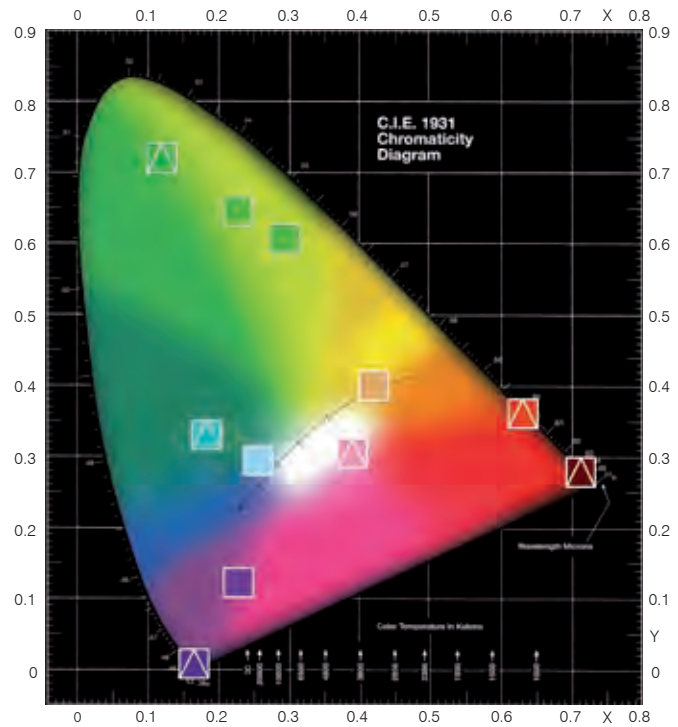

Area within white line: CMY system only
Area within yellow line: CMY + CTO

CMY only		X	Y	TRASM.
	yellow	0.4437	0.5448	82.34
	cyan	0.1355	0.1671	24.52
	magenta	0.3178	0.1144	12.38
	caldo	0.4970	0.4234	47.05
	green	0.1407	0.7850	11.84
	red	0.6602	0.3393	10.84
	blu	0.1636	0.0135	0.95

CMY + CTO		X	Y	TRASM.
	yellow	0.5352	0.4264	43.91
	cyan	0.1622	0.1699	2.08
	magenta	0.5672	0.2759	10.24
	green	0.2451	0.7126	1.36
	red	0.6618	0.3379	9.63
	blu	0.1701	0.0168	0.11

First colour wheel		X	Y	TRASM.
	blu	0.1675	0.0104	0.42
	orange-amber	0.6309	0.3683	20.13
	aquamarine	0.1857	0.3246	38.29
	deep green	0.1204	0.7208	24.08
	wood			
	dark red	0.7154	0.2823	2.14

Second colour wheel (Wash version)		X	Y	TRASM.
	TC190	0.4294	0.4068	52.46
	lavanda	0.2297	0.1159	9.00
	light green	0.2391	0.6444	51.42
	CTB 8000	0.2591	0.9213	63.46
	light pink	0.3896	0.3067	53.04
	green	0.2956	0.6105	64.97

Alpha Spot HPE - Alpha Profile Alpha Wash

FEATURES SHARED BY THE ALPHA SPOT 1500 MODELS

From 7° to 60° in a split second

Alpha 1500s have an extraordinary zoom, which even thrills the lighting operators themselves.

The beam angle in the Spot and Profile versions ranges from a maximum of about 60° to a minimum of less than 7°, with an incomparable aperture ratio of 1:8.5. This masterpiece of optical technology allows really extreme beam angles, making these spotlights absolutely versatile for short-throw and long-throw jobs. The 60° to 9.5° range is perfectly linear. Whereas there is an additional not-linear range from 9.5 to 7°, which is extremely useful mainly for ultra short-throw projections.

The speed of this zoom is spectacular: the full angular range can be gone through in just 0.5 sec. This speed, which corresponds to 120 complete zoom cycles per minute, has never been seen before in optical systems of this kind! The cycle may be repeated endlessly between any two beam angles with absolute precision. This creates a pulsating effect that makes the audience feel instantly immersed in the scene of coloured light.

Automatic focusing: a dream comes true

The Alpha Spotlight HPE and Profile 1500 have an absolutely extraordinary function: the patented “Stay Sharp Zoom” (SSZ) device that keeps the image in focus automatically while the zoom goes from one beam angle to another, even when the focal plane of the projected visual effect changes.

The SSZ device may be turned on and off as required and operates in the range from 9.5° to 60°, where the zoom is linear. In the additional range from 9.5° to 7°, focusing is traditional, i.e. done manually by the programmer.

Thanks to this function - never seen before in the sector - programming becomes easier. A sophisticated algorithm instantaneously and automatically repositions every single lens in the array according to the new zoom beam angle.

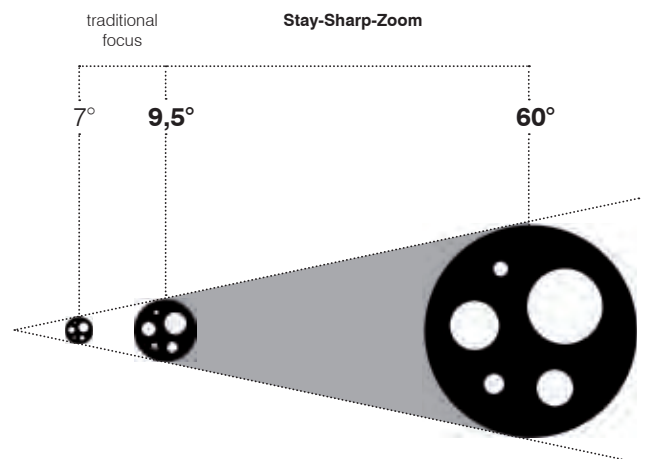

The operator no longer has to worry about loosing the sharpness of the projection.

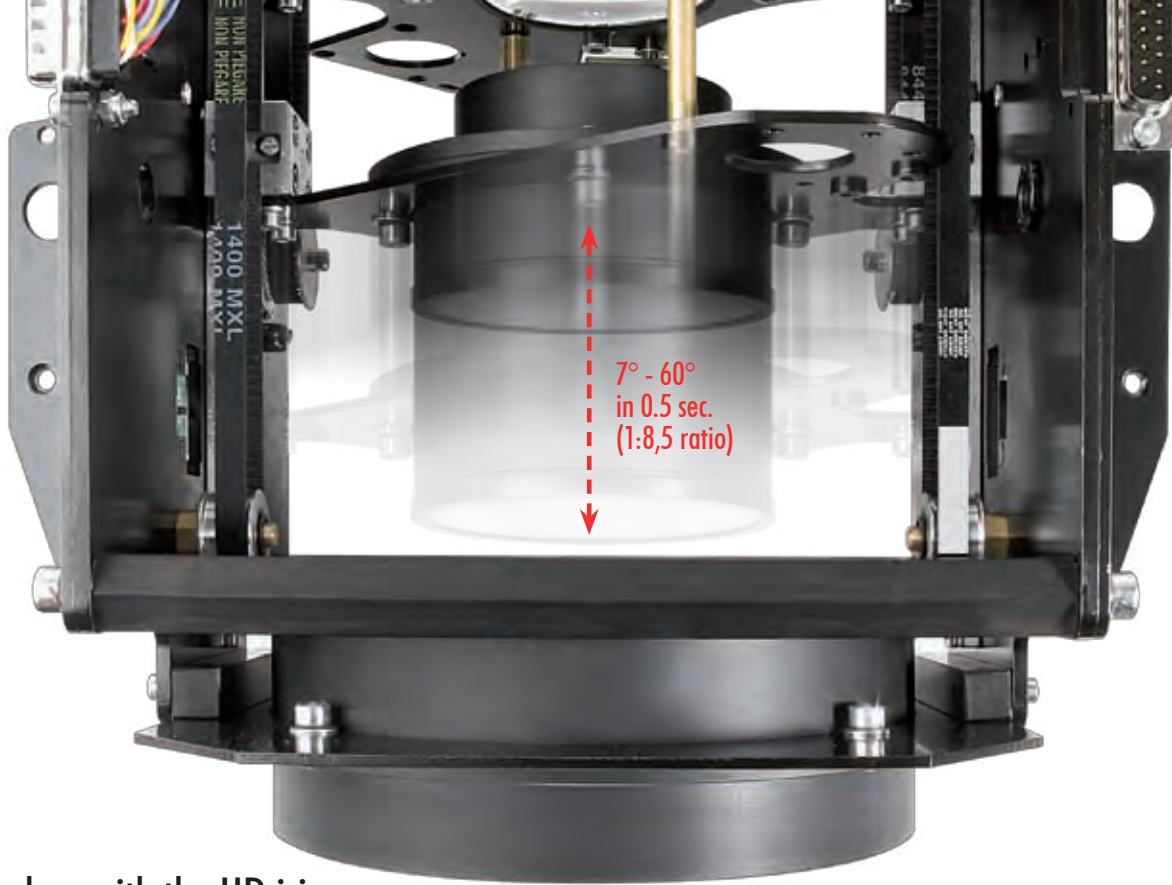

Rounded edges with the HD iris

The extremely wide beam angles the Alpha 1500 zoom is capable of may project enormous images where every single detail is enlarged, especially in short-throw use. For this reason, the iris consists of a very special diaphragm made up of 16 blades that form an almost perfect circle. Its diameter may be changed at a speed that can reach a staggering maximum. A sequence of high frequency iris openings and closings may be used as an exciting pulsating light effect, especially if combined with maximum zoom angles.

The blades of this special diaphragm are made of a new self-lubricating material that withstands great mechanical and thermal stress.

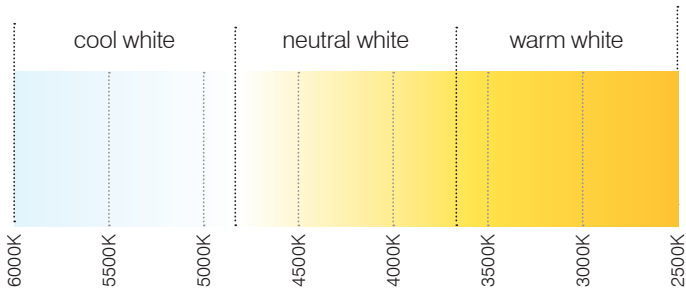

Linear colour temperature control

Besides CMY mixing and the fixed colour wheel, the Alpha Spot HPE 1500 and Profile 1500 versions have a CTO device for gradual colour temperature adjustment. The shade of the correction filter has been carefully chosen according to the colour spectrum of the lamp and allows linear adjustment from the rated 6000 K to up to 2500 K.

The linear CTO system provides excellent colours even in the warm section of the colour spectrum.

Perfect diffusion at every beam angle with the Zoom-Tracking-Diffuser

Going from a hard-edge beam to a soft-edge beam is optimized by an ingenious device consisting of a high quality frost lens that moves integrally with the zoom unit. This means the diffusion level may be adjusted linearly. Since the device moves with the zoom, diffusion is perfectly uniform and does not have the hotspots typical of frost filters. The resulting effect goes from slight blurring of the edges to wide-spread light diffusion, very similar to a washlight effect.

ALPHA PROFILE 1500

Code C61330

The energy of a rock-concert luminaire with the elegance of a theatrical profile-spot

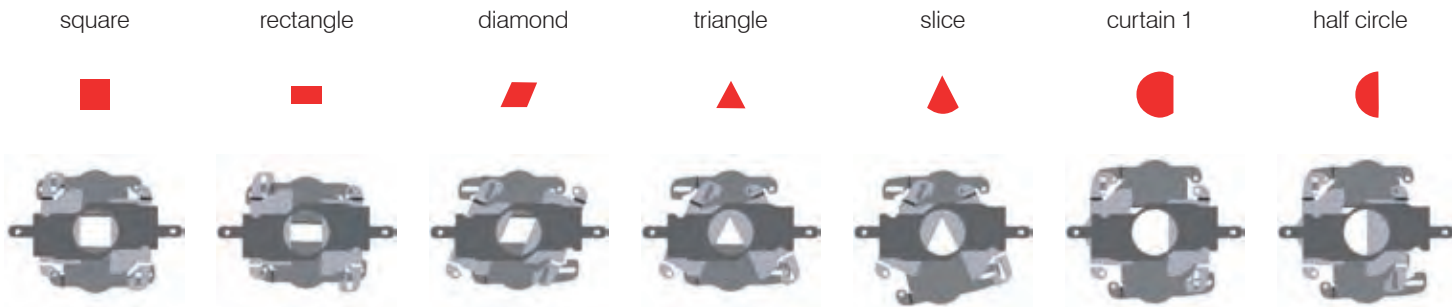

The precision micromechanics of the framing system uses worm gears that ensure perfect repeatability and do away with continuous manual adjustments.

A framing system without shape limits

Clay Paky has equipped the Alpha Profile 1500 with the most ingenious framing system ever produced in the show lighting industry. It consists of four independent overlapping blades that create shapes of all sizes, not just quadrangular, but also triangular. It is the only system able to work simultaneously on four different focal planes. The exclusive "curtain effect" (patented) allows gradual total closure of the shape using any one of the four blades. The shape made may also be turned around itself up to an angle of 90°, either to change its orientation or keep it fixed as the light beam moves. Blade movements and rotation take place very gently at a freely adjustable speed. With all these features, the Alpha Profile 1500 is an extraordinary tool for theatrical use, in television studios or on the sets of large events, where it can fashion light beams without limits and frame scenic elements precisely with fixed or animated light.

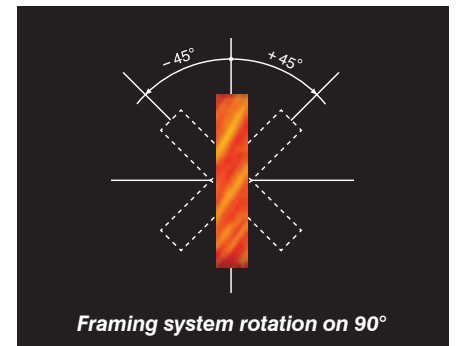

Soft-edge filter

A frost filter is available, in addition to the Zoom-Tracking-Diffuser, that may be turned on and off, to blur the edges of the shaped beam or gobo images.

curtain 2



open curtain



closed curtain

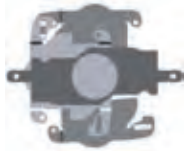

ribbon



square-corner
trapezium



trapezium

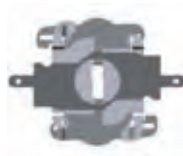

Projected images with exemplary quality

The Alpha Profile 1500 provides the most complete range of visual effects you could ever wish for:

- A wheel with 8 fixed gobos
- A wheel with 6 rotating gobos
- All the gobos are made of high definition laser engraved high quality dichroic glass
- The two gobo wheels may be overlapped to create morphing effects
- The “gobo fine” channel ensures utmost positioning precision, which is essential for long-throw use and when the projected image has to be perfectly oriented.
- A five-faced rotating prism can multiply any simple or compound image.
- To make programming easier, the operator can use the macro channel where it is possible to choose from a large number of pre-set combinations of totally new, highly attractive, elegant effects that are often impossible with other lights.

ROTATING GOBOS \varnothing 37.5 mm, image \varnothing 25 mm



084628/001 084626/001 084625/001 084630/001 105115/802 084632/001

FIXED GOBOS \varnothing 31.5 mm, image \varnothing 23 mm



085906/001 085912/001 085904/001 085908/001 085907/001 085903/001 085911/001 085901/001



ALPHA PROFILE 1500

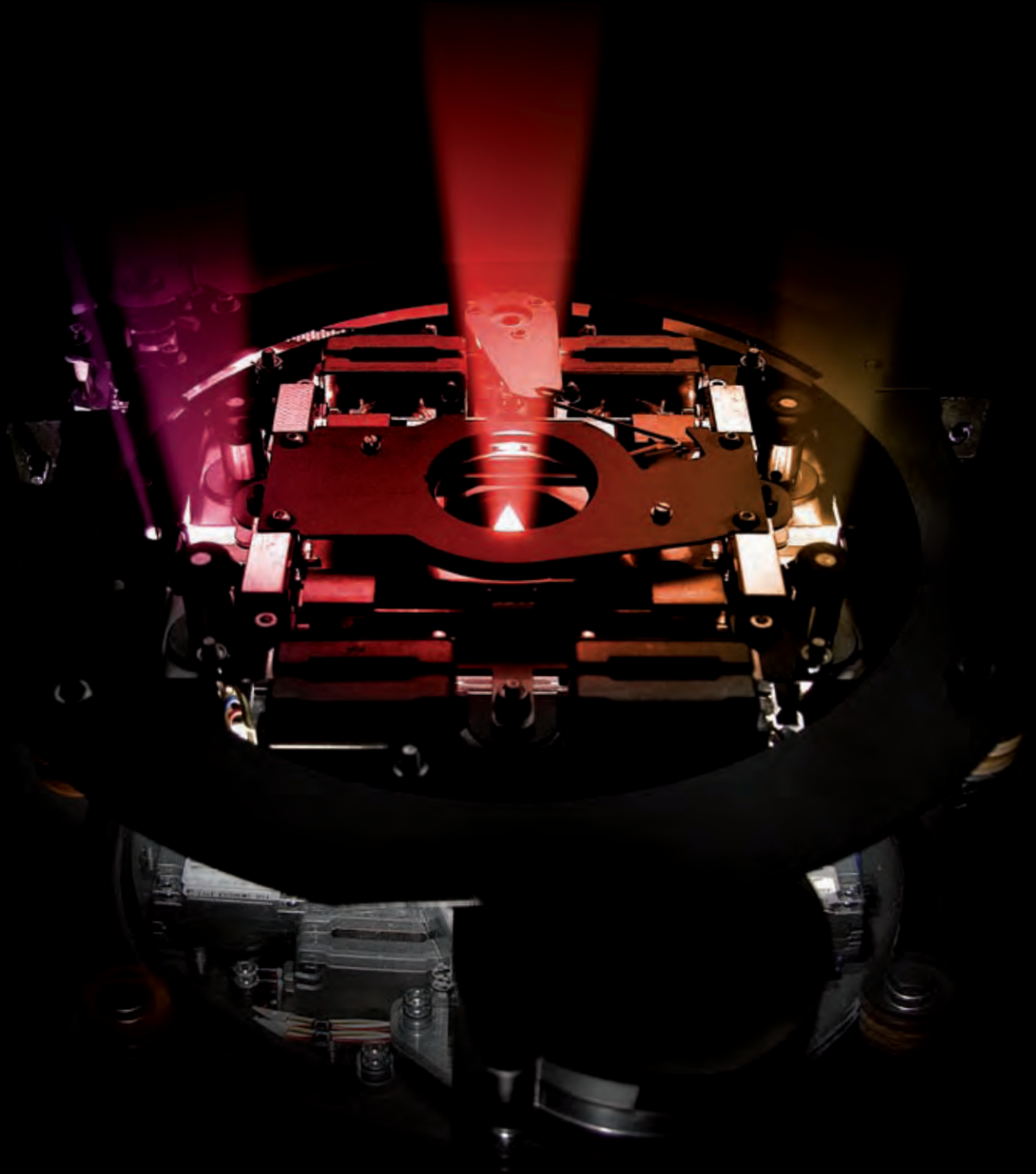

ALPHA SPOT HPE 1500

Code C61325

An inexhaustible visual effects generator

All the tools and... very much more

On a catalogue, it is hard to illustrate the sharpness of an image, the beauty of the effects, and the incredible combinations which can be achieved with the Alpha Spot HPE 1500, the most complete special effects spotlight on the market:

- One wheel with 8 fixed gobos
- 12 rotating gobos on 2 wheels
- All the gobos are made of high quality dichroic glass with original designs
- With two wheels, the gobos can be overlapped to create a morphing effect
- A five-faced rotating prism can multiply any image
- The “gobo fine” channel ensures utmost positioning precision, which is essential for long throw applications, when several spotlights are used together or when the projected image has to be perfectly oriented in space.
- The operator may use the “Dyna-Cue-Creator” function to simplify programming, with its infinite pre-programmed combinations of highly attractive refined effects, that are often impossible with other lights.

ROTATING GOBOS Ø 37.5 mm, image Ø 25 mm



084628/001 084629/001 084624/001 105115/801 105115/802 084632/001 084627/001 084626/001 084625/001 084631/001 084630/001 084633/001

FIXED GOBOS Ø 31.5 mm, image Ø 23 mm



085906/001 085912/001 085904/001 085908/001 085907/001 085903/001 085911/001 085901/001

Glass animation wheel

The Alpha Spot HPE 1500 animation disc is a special transparent glass plate with an uneven surface that deforms the projected image. As it turns, it generates textures that change and move continuously with varying speeds, depth of field or focus. With a suitable choice of gobos, it is possible to simulate typical theatrical effects, such as flames, waves, wind, fireworks, a liquid mass and a vortex. Extremely beautiful abstract patterns may also be created using specially worked glass discs. For example, using a microperforated gobo, you get a merry-go-round of precious crystals that chase each other.

The animation disc is fitted with a magnetic coupling system so it can be swapped quickly with other animation discs, available on request.

The Animation disc, with a suitable choice of gobos, simulate a wide range of typical theatrical effects .



A never-seen-before effect: the Animated-Star-Gobo

You will find a never-seen-before effect on the Alpha Spot HPE 1500: a “reverse function iris” that does not produce a circle, but a “star” shape. The star shape is not fixed, but changes and pulsates with the opening and closing of the adjustable-speed iris.

The Animated-Star-Gobo device (patented) adds never-seen-before ways to shape the light beam artistically.

Dyna-Cue-Creator

Alpha 1500s abound in powerful spectacular devices. For this reason, they can be complex machines to use. However, Clay Paky has created a tool to make the user’s work easier: the “Dyna-Cue-Creator” function. The “macro” channel in other spotlights contains a selection of static projections, but in the Alpha 1500s it is a library of dynamic - often three-dimensional - animations that lighting designers may use in their shows almost automatically. The “Dyna-Cue-Creator” is the result of meticulous artistic research: the zoom, focus, iris and dimmer functions are combined and synchronized with each other in many different ways that may be customized by lighting designers (with colours, gobos, speed and other effects). The “Dyna-Cue-Creator” is easy to use owing to the autofocus extremely rapid and constant adjustments; lighting designers no longer have to program continuous focus corrections with benefits that are particularly evident in the most complex cues, where the gobo, focus plane and zoom angles change simultaneously.

Macros can be applied to both individual projectors and a series of projectors. In automatic mode, you can use the “random” function to make more than one projector use the same macro in a synchronized way. You do not have to manage phase shifts because synchronization is controlled automatically by the projector and not from the console. The only decision you have to make is whether to apply the macros to one projector or a group of projectors.

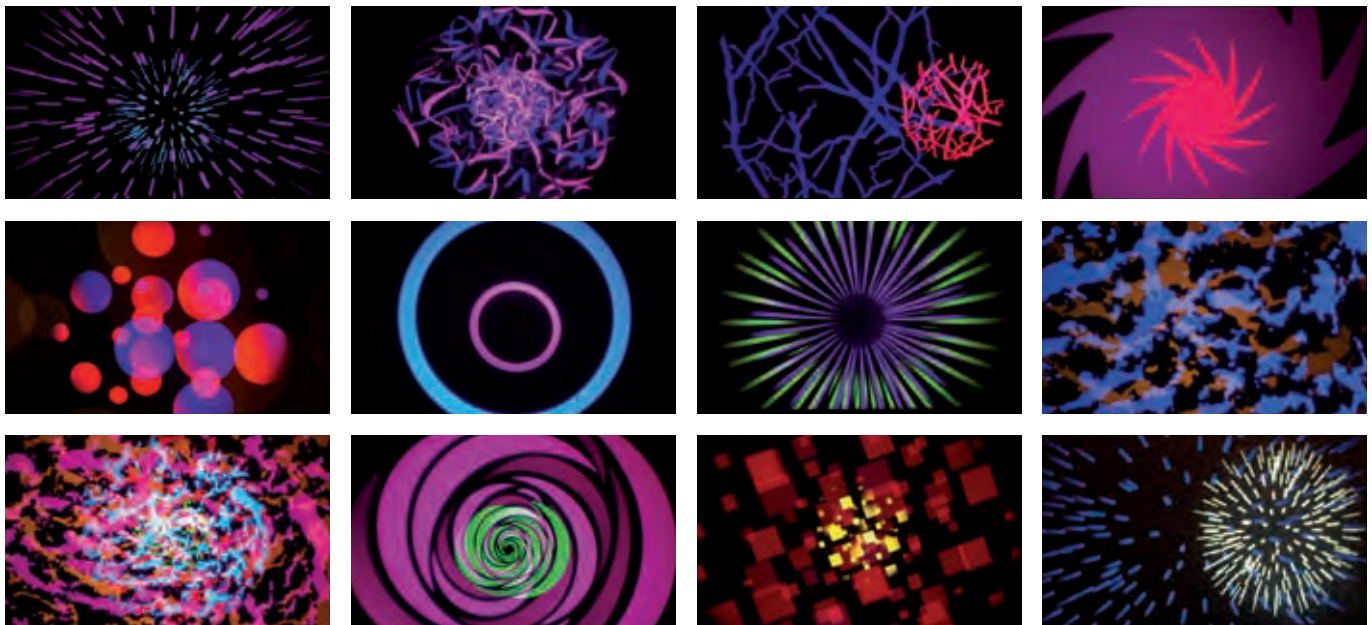

The “Dyna-Cue-Creator” function opens doors for lighting designers to a universe of spectacular, creative solutions



ALPHA SPOT HPE 1500

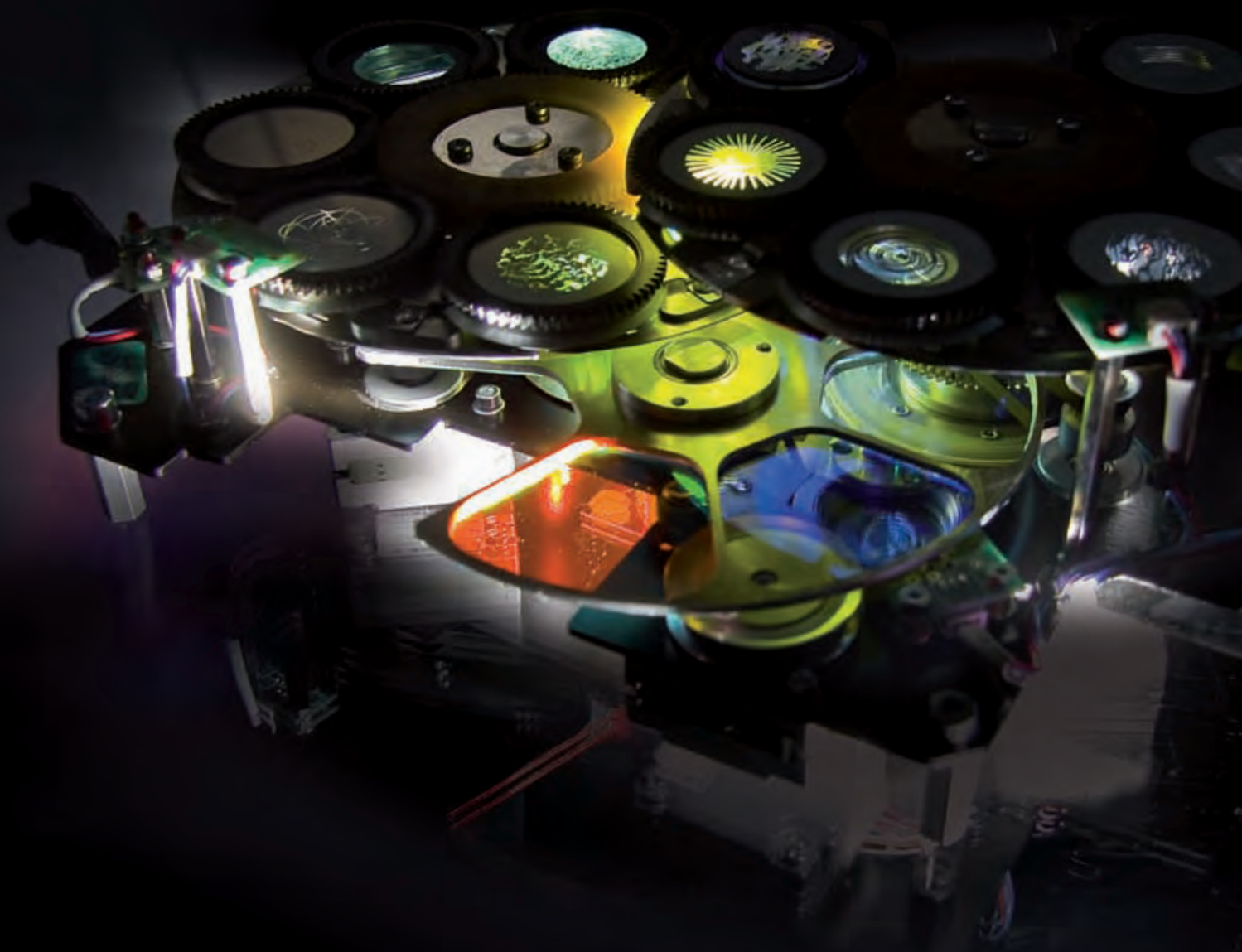

ALPHA BEAM 1500

Code C61310

An extremely powerful automated ACL: star of the biggest events



A new category of spotlight for shows

By motorizing the narrow beam of concentrated ACL light, Clay Paky has invented a new category of spotlight, the “Beam Moving Light”. Alpha Beam 1500 is the top model in this category, in power, abundance of devices and spectacularity of light effects. The Alpha Beam 1500 is extremely fast: in a moment, it points at the stage, then at the audience, then up into the sky at open-air events. It can be an exciting blinder or striking dynamic colour-changing sky tracker. For this reason, the Alpha Beam 1500 has already become the star of world famous events, such as the inauguration ceremonies of large shows, international sporting events, and concerts by famous artists.

All the tools for shaping the beam

The Alpha Beam 1500 produces a highly visible, dazzling, solid bar of light, whose diameter may be modified by adjusting the iris. Its shape may be changed thanks to a vast set of devices, i.e. several effects can be created in mid-air:

- 14 dichroic gobos (6 rotating + 8 fixed)
- 3 rotating prisms (5-face, 6-face and beam shaper)
- high speed iris
- a hybrid dimmer (100-50% electronic, 50%-0 mechanical) changes beam intensity
- a shutter/strobe adds the possibility of flashing and instantaneous black-out.

ROTATING GOBOS Ø 37.5 mm, image Ø 25 mm



084618/001 084619/001 084620/001 084621/001 084622/001 084623/001

FIXED GOBOS Ø 31.5 mm, max image Ø 23 mm



085910/001 085801/001 085802/001 085606/001 085603/001 085909/001 084702/001 085601/001



A level of brightness never achieved before

Thanks to the special optical unit invented by Clay Paky, the Alpha Beam 1500 concentrates light into a beam that is very much brighter than those of any other spotlights with the same power. Its beam stands out against any background. It is a perfect blade of light in multimedia shows that cuts through - with breathtaking effects - the brightness of washlights or the LED video systems that fill the backdrops of stages. Even though the beam is generated by a light source of only 1500 watts, it is bright for hundreds of metres: distances that until now could only be reached by search lights with powers of several thousand watts.

Patented focusing system

The Alpha Beam 1500 has an innovative patented focusing system that allows extremely bright effects to be projected. Focusing is achieved by moving the entire effects section and not just a single lens. This original solution is the fruit of Clay Paky research.

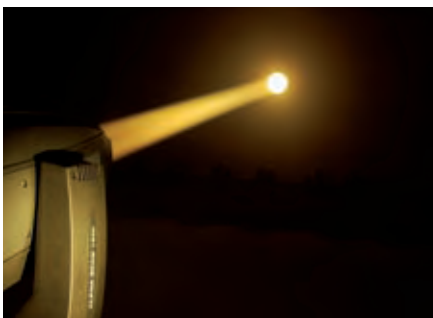

Standard Beam



Frosted Beam



Focused Pattern

Not just a beamlight... but a spotlight and even a washlight too

The Alpha Beam 1500 is the only beam moving light that can also become a washlight or a spotlight. Its colour-engine (CMY mixing, special colour wheel and CTO) and gradual frost diffusion support, make it an excellent narrow-angle washlight, ideal at large venues, arenas and stadia.

Furthermore the wide range of visual effect devices means the Alpha Beam 1500 can also be used as a spotlight, not just for effects in mid-air, but also for clear gobo projections, which become beautiful decorative images when the two rotating prisms are used (similar to those of a powerful moon-flower effect).

The Alpha Beam 1500 should not be seen as a niche light, devoted to special effects, but as a versatile tool to be chosen for its spectacular beams and used during the same show in many different ways.



ALPHA BEAM 1500

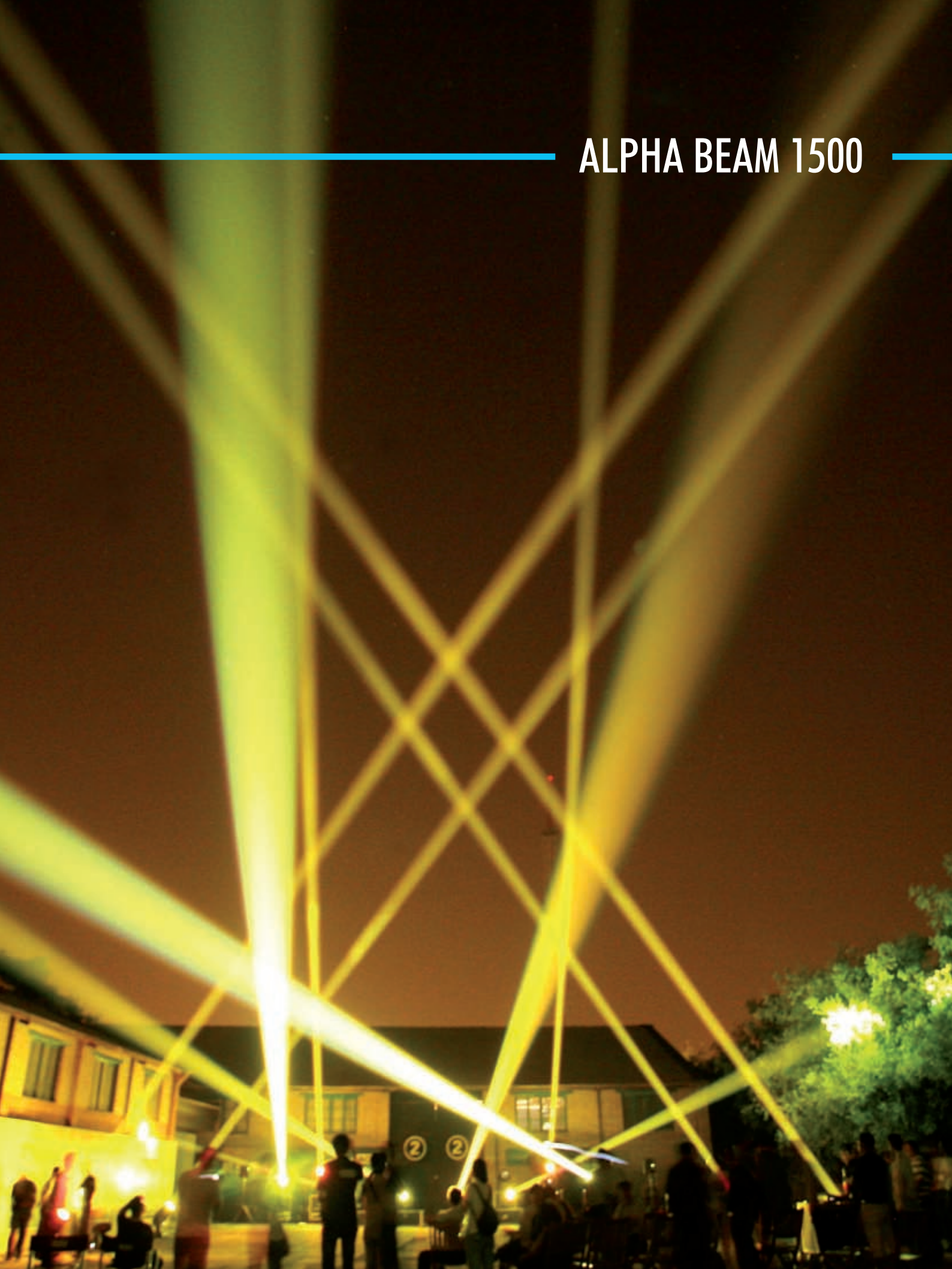

TWO WASHLIGHT MODELS COVERING ALL APPLICATION NEEDS



Alpha Wash 1500 LT
Code C61315

Alpha Wash 1500
Code C61320

Incomparable luminous efficiency even at maximum beam angles

The Alpha 1500 line washlights provide an unapproachable brightness for any other washlight of the same category over the whole zoom range. The optical unit optimizes lamp power, even at maximum beam angles.

The Alpha Wash 1500 zoom ranges from 11° to 74°, so it can be used with no compromise both in long-throw applications (such as live events) and where distances are short (for instance in TV studios or theatres).

The Alpha Wash 1500 LT is the first long-throw washlight, with special optics. The zoom angle ranges from 10° to 32° (55° using the optional frost). The minimum angle provides perfect washlighting at distances other washlights find hard to reach. The Alpha Wash LT is therefore suitable for use in large arenas and stadia and for colouring stages on large tours from great distances.

The zoom is perfectly linear and uniform on both versions. It is very smooth at low speeds and amazing at top speed.

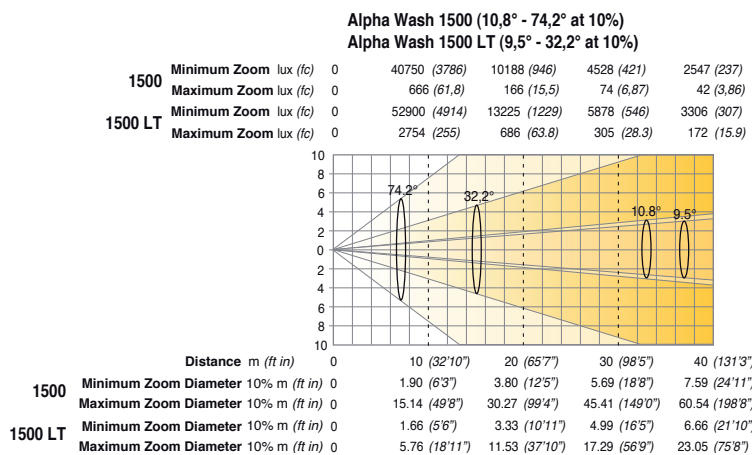

Colour also has a shape

The washlight beam may be diffused evenly or shaped:

- Using an adjustable ovalizer filter with banana effect.
- Using the "diamond filter", which concentrates the light on two perpendicular axes and produces a particularly attractive effect in backlighting.
- Both effects may rotate in both directions at a freely adjustable speed.
- The beam shaper effect may be more or less accentuated by moving the whole lens array in or out. At the same time the light goes from "narrow beam" to "wide beam".



The colour creator

Alpha Wash 1500s have an incomparable capacity in terms of the quantity, quality and reproducibility of the colours they generate. This is thanks to a powerful colour-engine consisting of a CMY device, wheels with six special colour filters (two for the normal washlight, one for the LT washlight) and a special "Golden CTO" device that adjusts the colour temperature from 2500 K to 6000 K.

The range of colours is inexhaustible both for saturated colours and pastel shades. The warm shades created in the frequency area between yellow and orange are particularly beautiful, thanks to the "Golden CTO" device.

A dedicated channel, named the "Alpha Color Palette", has been created to help lighting designers find artistic solutions. It contains an extremely wide range of preselected colours, formed by combining all the beam colouring devices in a great variety of ways.

Lastly, for those who wish to use traditional gels with Alpha Wash 1500s, gels may be safely fitted externally to the front lens using the patented "Magnet Gel Holder" system.

Diamond Effect

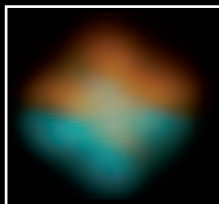
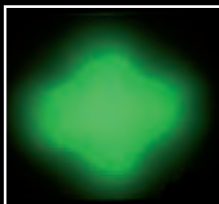
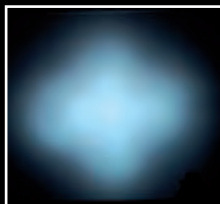

Ovalizer Effect

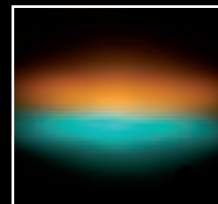

Magnet Gel Holder



ALPHA WASH | WASH LT

Comparison of two washlights

FEATURE	ALPHA WASH 1500	ALPHA WASH 1500 LT
Linear zoom angle	from 11° to 74°	from 10° to 32° (55° with opt. frost)
Lux at 10 m with 11° beam angle	40,750	50,000
Colour-engine	CMY + 2 colour wheels	CMY + 1 colour wheel
Golden CTO system (linear)	from 2500 to 6000 K	From 3000 to 6000 K
Rotating Beam Shaper	Ovalizer + diamond filter	Ovalizer + diamond filter
Beam Diffuser	Yes	No
Switchable power 1500/1200 W	Yes	No
Colour-macros	Yes	No

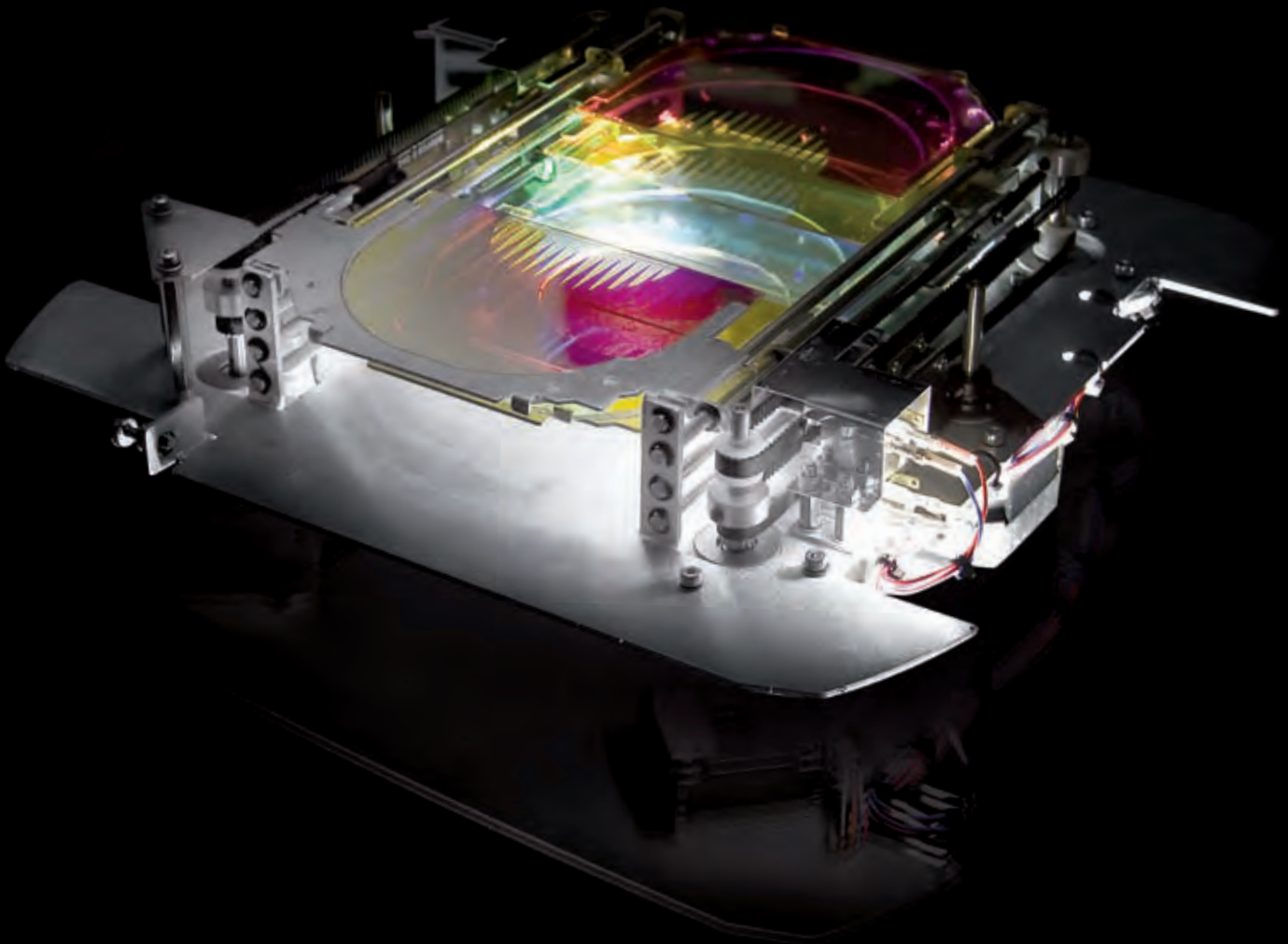

OVERVIEW

TECHNICAL DATA	ALPHA PROFILE 1500
Light source	Osram Lok-It 1500W
- Color Temperature (K)	6,000
- Luminous Flux (lm)	135,000
- Nominal Life (h)	750
- Socket	PGJ50
Power supplies available	200-240V 50/60Hz
Input Power	2,000VA
Electronic Ballast	•
Lamp controlled from the Lighting desk	•
Electronic Linear Zoom	9,5° to 60°
Extra Zoom range	7° to 9,5°
Electronic Focusing	autofocus
CMY	•
Linear CTO	•
Color Wheel	1 (6 colors + white)
CTO filter	
Frost	Zoom tracking + flood
Rotating gobo wheels	1 (6)
Fixed gobo wheels	1 (8)
Morphing effect	•
Rotating animation disc	
Rotating prisms	1(5 facet)
Rotating beam shaper(s)	
Mechanical high speed iris	HD
Animated Star Gobo (patented)	
Framing system (patented)	•
90° rotation of the framing system	•
0-100% dimmer on a dedicated channel	•
Shutter/strobe	•
Long life self charging buffer battery	•
Preset macros	•
Fuction reset from control unit	•
Autotest routine	•
Ethernet ready	•
Electronic monitoring with status error	•
Cooling system monitoring	•
DMX level monitoring on all channels	•
Internal data transmission diagnostics	•
Parameter electronic setting auto recovering	•
Firmware Upgrade with no power	•
Firmware upload from another fixture	•
Adjustable power (1,500 - 1,200 W)	•
PAN and TILT lock on 4 and 7 positions respectively	•
DMX control channels	39/43
Weight (Kg/lbs)	49.5 (109.13 lbs)
Dimensions LxWxH (mm/inches)	488x480x835 (19.21"x18.90"x32.87")

PHOTOMETRICS

ALPHA PROFILE 1500

Standard (6,9° - 59,9°)

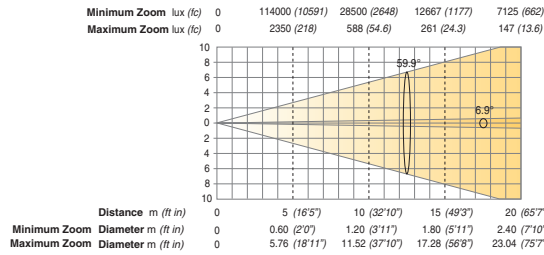

with light Frost (8,5° - 59,9°)

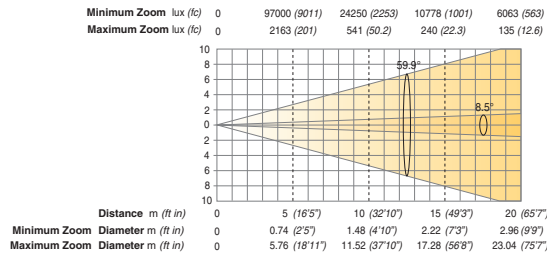

with heavy Frost (5,3° - 42,0° at 50%; 9,6° - 66,2° at 10%)

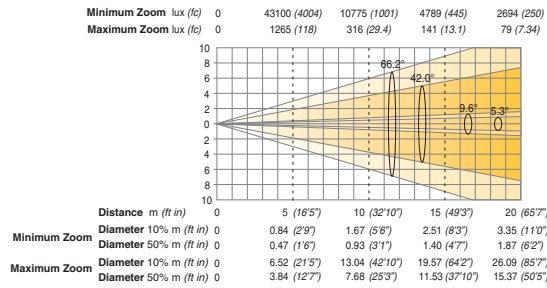

ALPHA SPOT HPE 1500

Standard (6,9° - 56,4°)

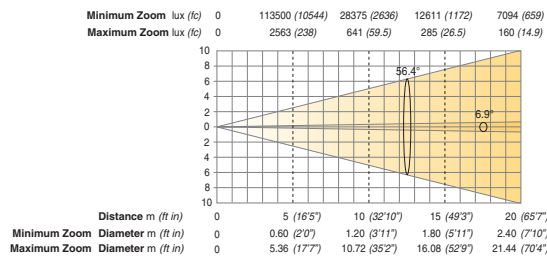

with Frost (4,7° - 40,1° at 50%; 8,5° - 63,8° at 10%)

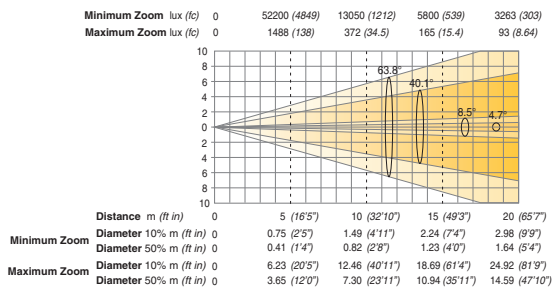

Diameter 10%-50%: beam diameter for 10% and 50% of maximum illumination.

ALPHA BEAM 1500

Standard (4,2°)

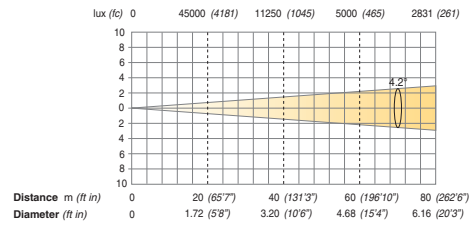

with Heavy Frost (5,2° 50% - 11,3° 10%)

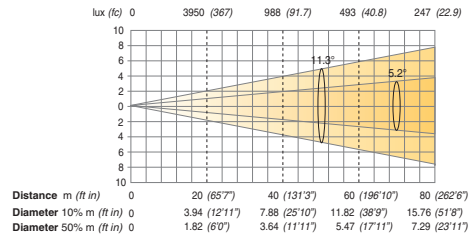

with Ovalizer filter (X and Y axis)

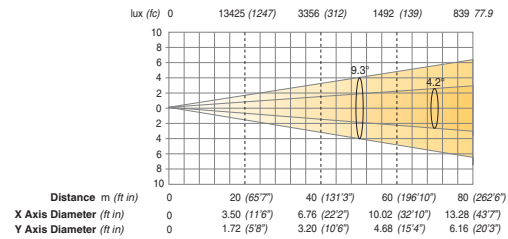

ALPHA WASH 1500

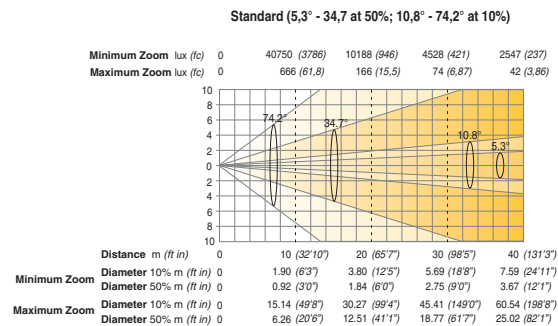

ALPHA WASH 1500 LT

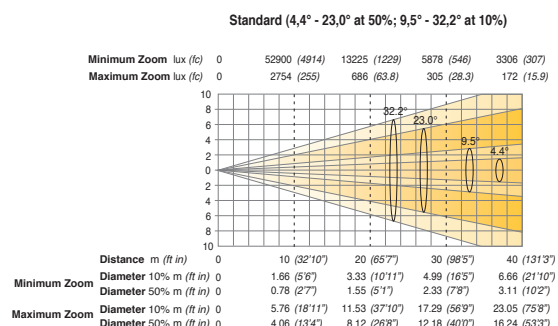

Minimum Zoom with diffuser lens (7,0° 50% - 13,4° 10%)

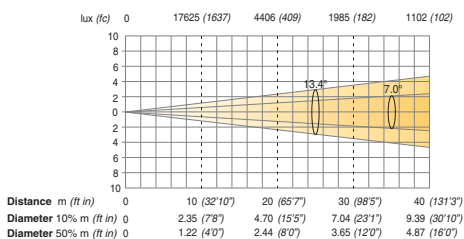

with optional Heavy Frost (7,8° - 24,4° at 50%; 16,4° - 54,5° at 10%)

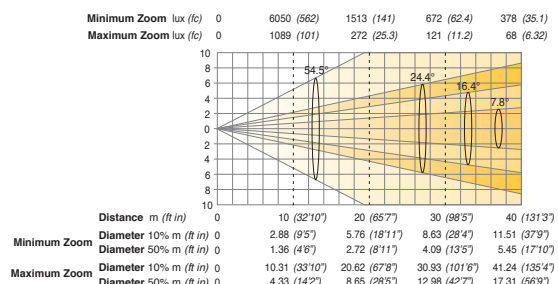

Minimum Zoom with Ovalizer filter (X and Y axis)

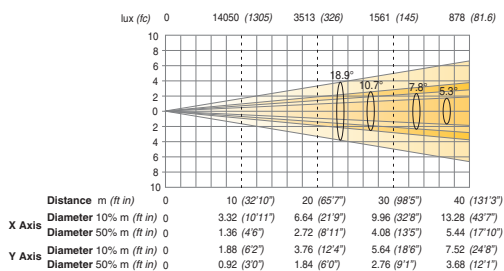

Minimum Zoom with Ovalizer filter (X and Y axis)

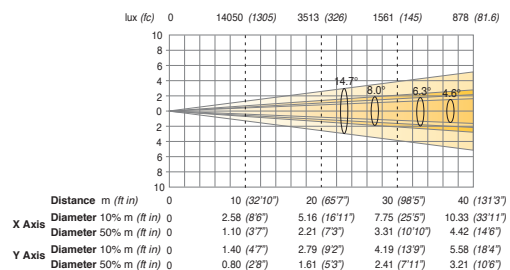

PATENTS (or pending patents)

The extensive Clay Paky research that went into creating these cutting-edge devices is attested by the large number of international patents registered and patent applications submitted for the Alpha 1500 line. Here are the most important:

- Quick spring-lock system for interchangeable fixed and rotating gobo discs.
- Entire effect-assembly movement for focusing with fixed front lens position.
- Flexible electric cabling system for the moving Zoom-Tracking-Diffuser unit
- Framing-system "curtain" effect (Profile model)
- Animated-Star-Gobo (Spot HPE model)
- Special lens with concentric dual-level frost finishing (Wash model).
- Diamond filter fitted on the rotating disc unit (Wash models).
- Magnetic support system for fitting external gels (Wash models).

SIZE & WEIGHT

ALPHA PROFILE | SPOT HPE 1500 ■ 49.5 Kg (109.13 lbs)

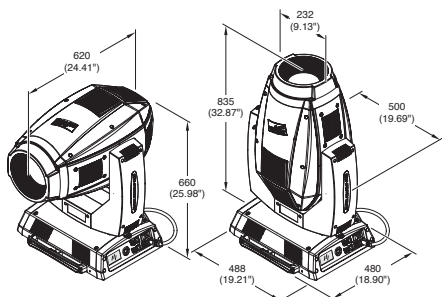

ALPHA BEAM 1500 ■ 40 Kg (88.18 lbs)

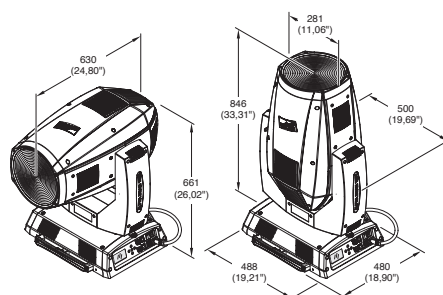

ALPHA WASH 1500 ■ 45 Kg (99.21 lbs)

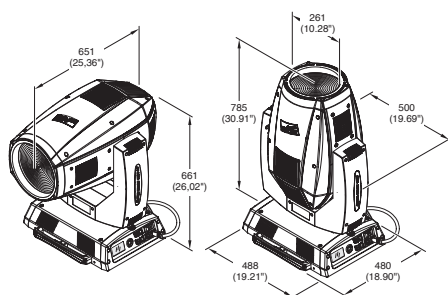

ALPHA WASH 1500 LT ■ 46,7 Kg (102 lbs)

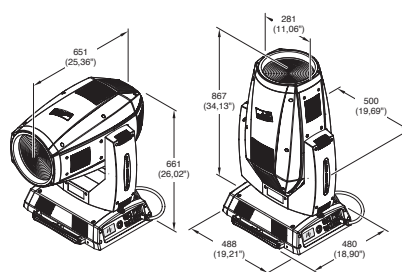

ACCESSORIES

Code L10096

LAMP - Supplied

OSRAM LAMP HTI 1500W/60/P50 LOK-IT

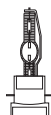

Code 183102/802

OMEGA - Supplied (2 pieces)

for fixing clamps

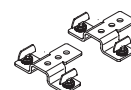

Code C21070

CLAMPS

48-51mm, max 300 Kg hook for truss



Code 105041/003

SAFETY CABLE

Ø 4mm, lenght 680mm



Code C61182

HANDLES

for products transportation

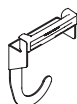

Code F21176

FOAM SHELL

Code C61187
HEAVY FROST FILTER KIT

(only for Alpha Wash 1500 LT)

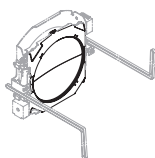

Code F21180
FLIGHT CASE

flight case
(including foam shell)
for 1 Alpha 1500

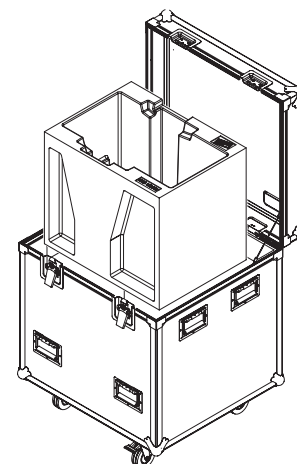

Code C61186

TOP HAT

(only for Alpha Wash 1500)

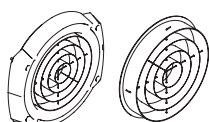



ALPHA 1500

*the wilder
side of light*

The agile Alpha 1500 leaves rivals further down the tree looking quite tame by comparison. Scratch the surface and discover what makes this wildcat such a unique piece of work. Besides its speed, silence and hair-breadth precision, the Alpha 1500 has an incredible auto-focusing zoom - supple enough to leap from 7 to 60 degrees in a single split second.

Clay Paky. Thoroughbred lighting since 1976.

www.claypaky.it



Profile



Spot HPE



Beam



Wash



Wash LT





www.claypaky.it

CLAY PAKY S.p.A.
I - 24068 Seriate (BG) - Via Pastrengo, 3/b
Phone +39 035 654311 - Fax +39 035 301876
www.claypaky.it - cp.info@claypaky.it



UNI EN ISO 9001